

Appalto integrato a procedura telematica aperta per l'affidamento dei servizi di architettura e di ingegneria per la redazione del progetto esecutivo e del coordinamento della Sicurezza in fase di progettazione e per l'affidamento dell'esecuzione dei lavori relativamente al sotto intervento n.01 "Riorganizzazione del percorso espositivo complessivo del Museo Nazionale Romano" nell'ambito dell'attuazione dell'intervento n.01 "URBS. Dalla città alla campagna romana" - Museo Nazionale Romano.

CUP F85F21003440001 - CIG 98778389C7

AREA D'INTERVENTO:

COMPLESSO MONUMENTALE DELLE TERME DI DIOCLEZIANO

Gallerie superiori del Chiostro di Michelangelo Sale delle cd. Piccole Mostre

UFFICIO TECNICO:

N.19/2023

Visto: 28 Giugno 2023

*Saveria Petillo*

Responsabile Ufficio Tecnico.  
Arch. Saveria Petillo

OGGETTO:

RILIEVO

PIANTA GENERALE STATO DI FATTO



PROGETTISTI INCARICATI:

Tav:

ril.01

Arch. Roberto Bassignani - (Capofila)

Prof. Arch. Francesco Murano



R.U.P.:

Doft. Sara Colantonio

Data:

Giugno 2023

Scala:

1:200

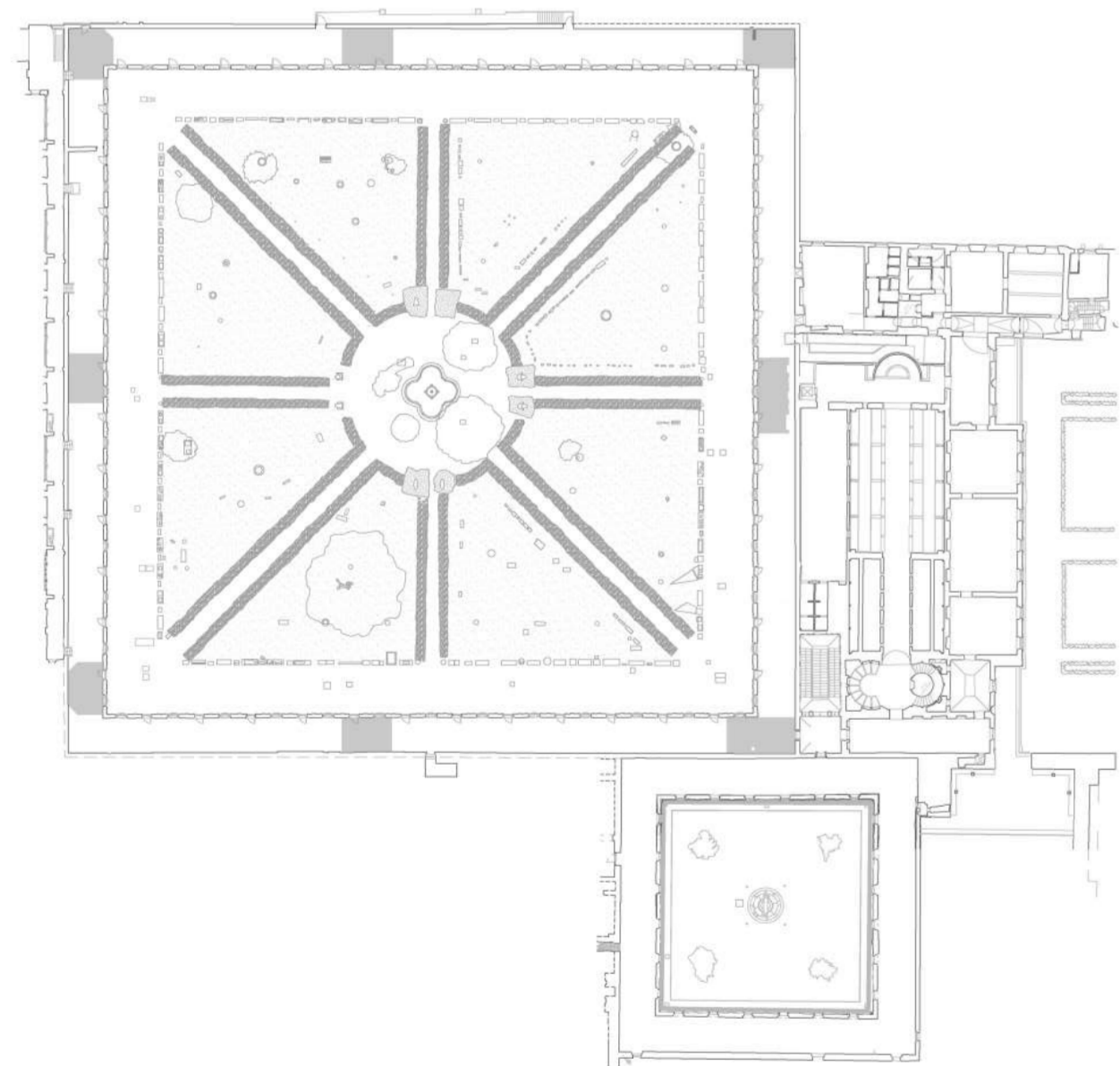

IL PROGETTO È REDATTO SUI RILIEVI FORNITI DALLA STAZIONE APPALTANTE

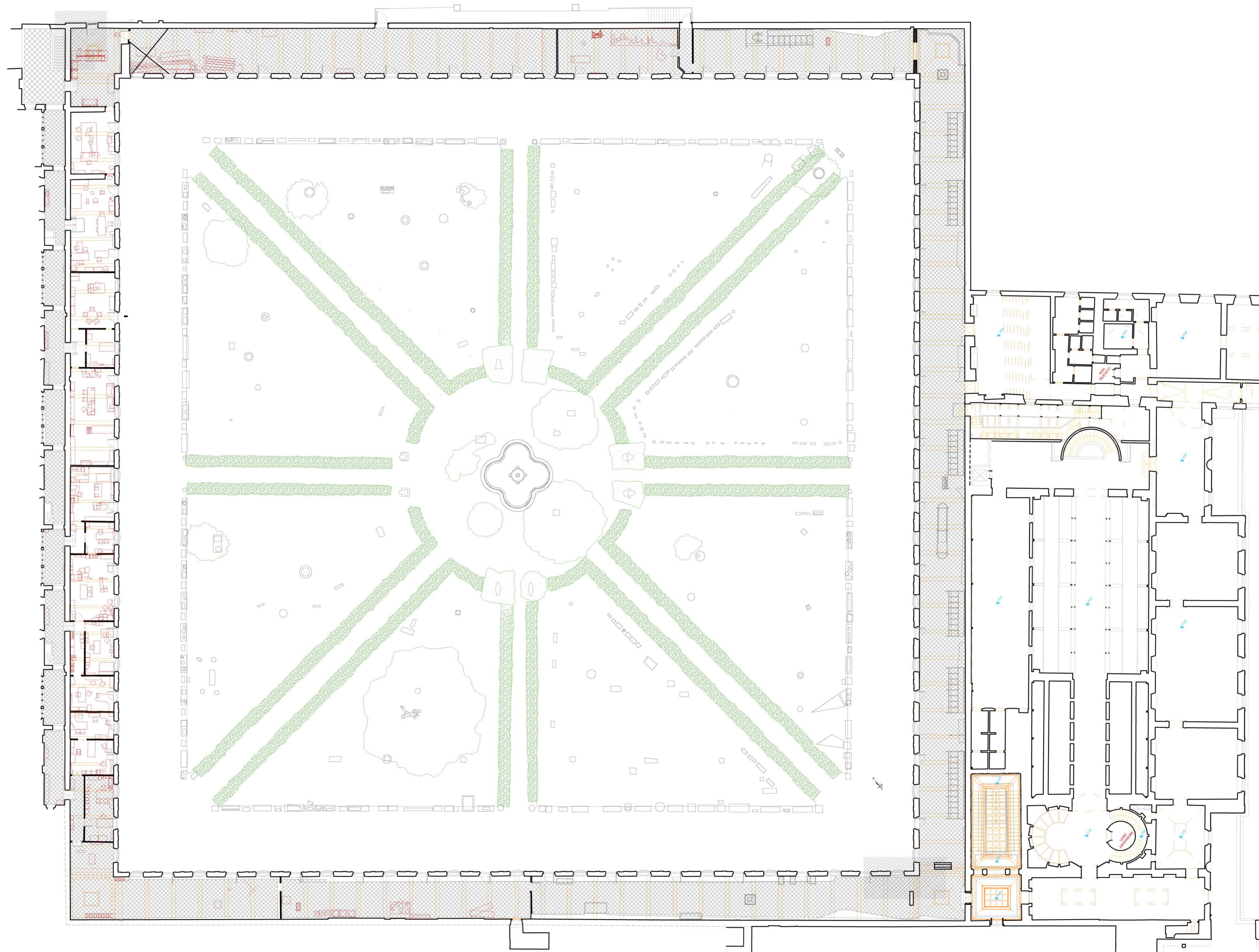

Appalto integrato a procedura telematica aperta per l'affidamento dei servizi di architettura e di ingegneria per la redazione del progetto esecutivo e del coordinamento della Sicurezza in fase di progettazione e per l'affidamento dell'esecuzione dei lavori relativamente al sotto intervento n.01 "Riorganizzazione del percorso espositivo complessivo del Museo Nazionale Romano" nell'ambito dell'attuazione dell'intervento n.01 "URBS. Dalla città alla campagna romana" - Museo Nazionale Romano.

CUP F85F21003440001 - CIG 98778389C7

AREA D'INTERVENTO:

COMPLESSO MONUMENTALE DELLE TERME DI DIOCLEZIANO

Gallerie superiori del Chiostro di Michelangelo  
Sale delle cd. Piccole Mostre

UFFICIO TECNICO:

N.19/2023

Visto 28 Giugno 2023

*Saveria Pettilo*

Responsabile Ufficio Tecnico.  
Arch. Saveria Pettilo

OGGETTO:

RILIEVO

PROSPETTI SEZIONI



PROGETTISTI INCARICATI:

Tav:

ril.02

Arch. Roberto Bassignani - (Capofila)

Prof. Arch. Francesco Murano



R.U.P.:

Doct. Sara Colantonio

Data:

Giugno 2023

Scala:

1:200

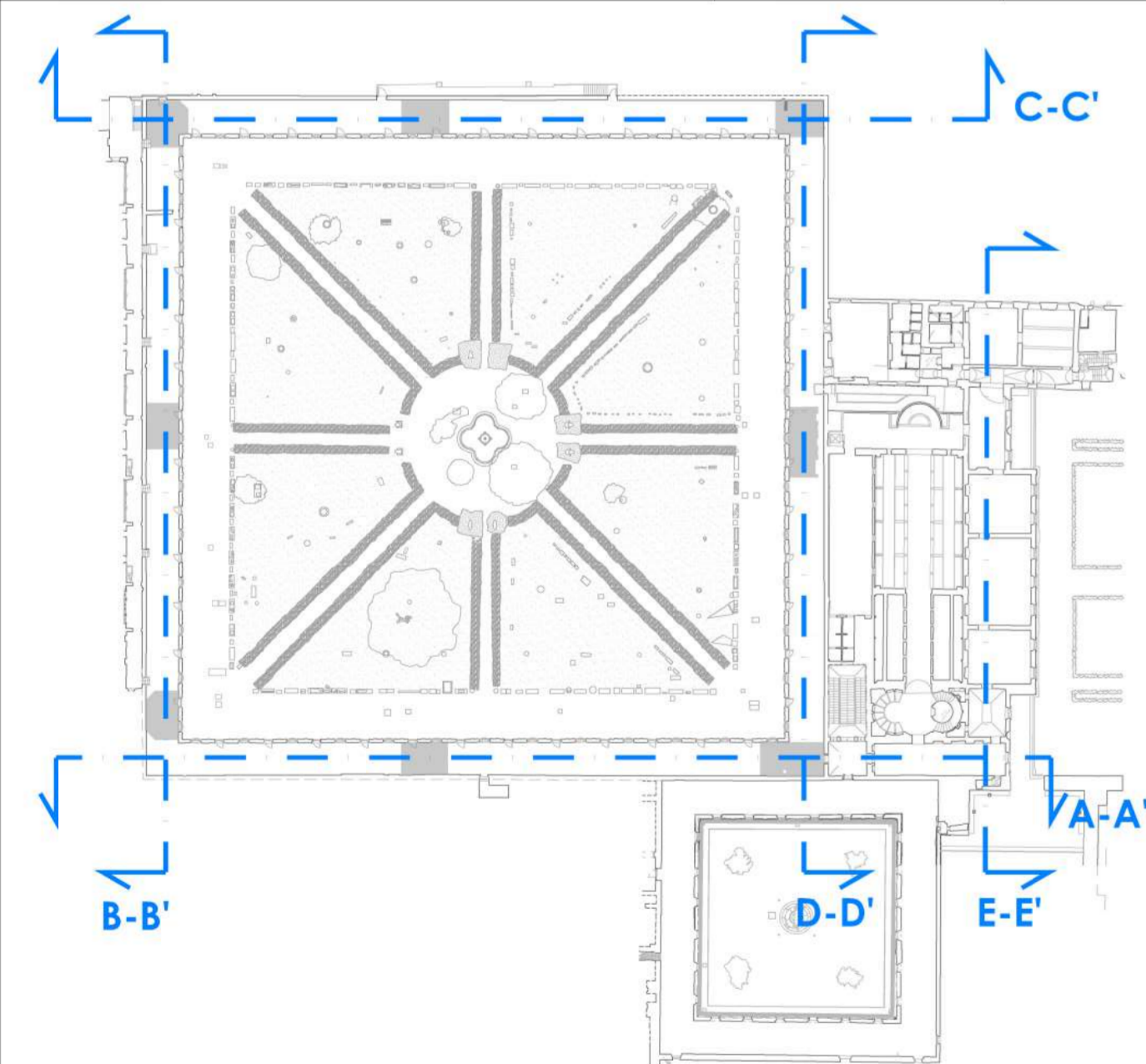

IL PROGETTO È REDATTO SUI RILIEVI FORNITI DALLA STAZIONE APPALTANTE

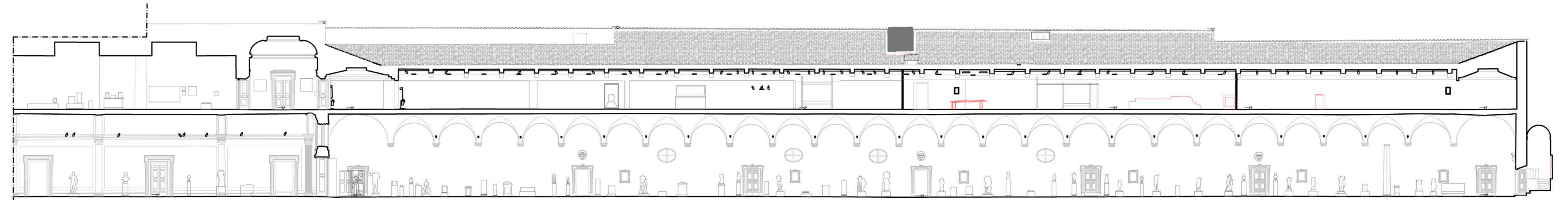

Prospetto Sezione A-A'

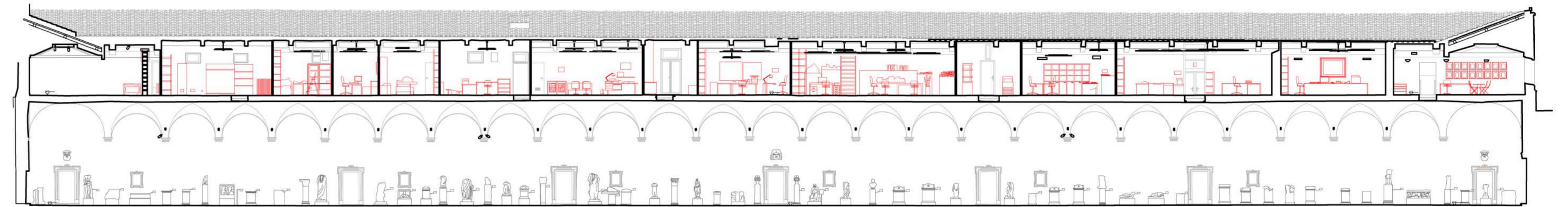

Prospetto Sezione B-B'

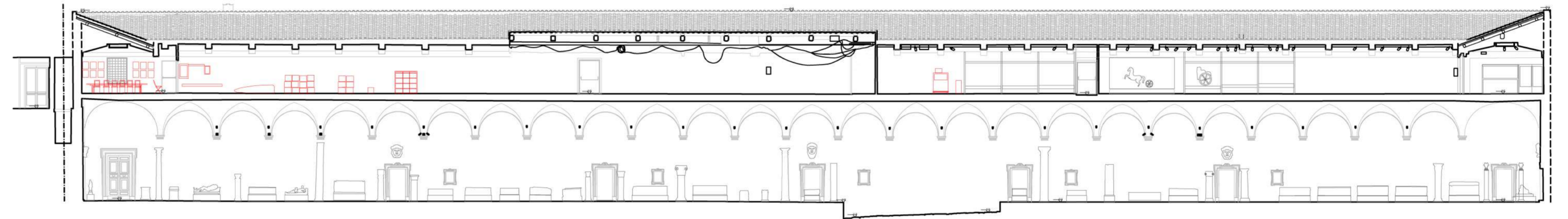

Prospetto Sezione C-C'

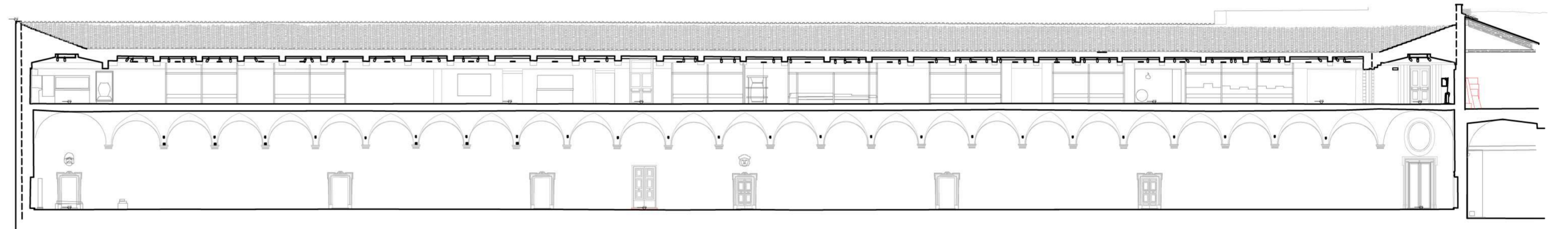

Prospetto Sezione D-D'

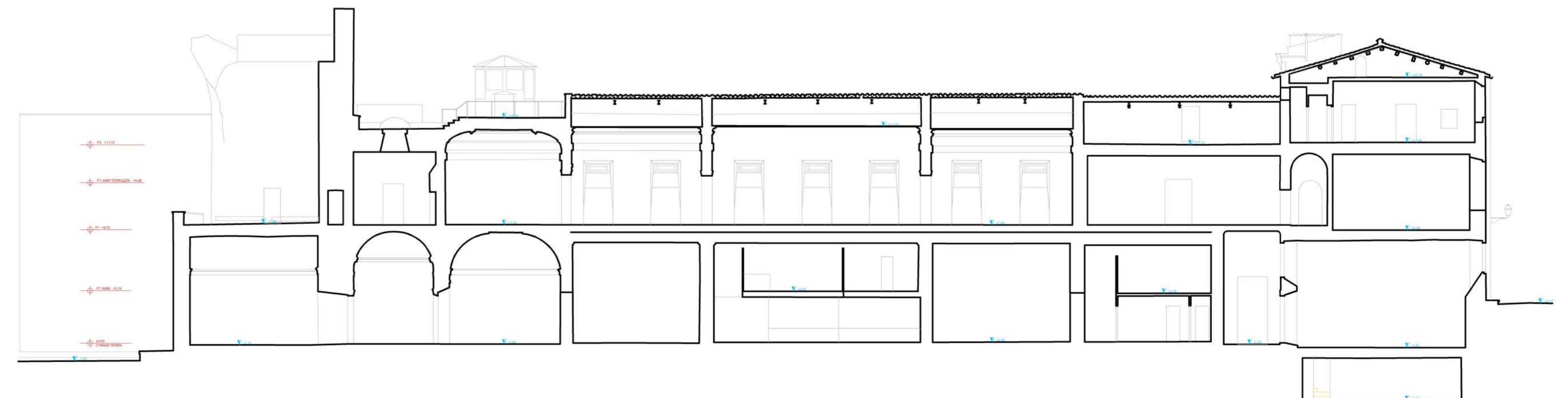

Prospetto Sezione E-E'

**Appalto integrato a procedura telematica aperta per l'affidamento dei servizi di architettura e di ingegneria per la redazione del progetto esecutivo e del coordinamento della Sicurezza in fase di progettazione e per l'affidamento dell'esecuzione dei lavori relativamente al sotto intervento n.01 "Riorganizzazione del percorso espositivo complessivo del Museo Nazionale Romano" nell'ambito dell'attuazione dell'intervento n.01 "URBS. Dalla città alla campagna romana" - Museo Nazionale Romano.**

**CUP F85F21003440001 - CIG 98778389C7**

**AREA D'INTERVENTO:**

**COMPLESSO MONUMENTALE DELLE TERME  
DI DIOCLEZIANO**

**Gallerie superiori del Chiostro di Michelangelo  
Sale delle cd. Piccole Mostre**

**UFFICIO TECNICO:**

**N.19/2023**

Visto: 28 Giugno 2023

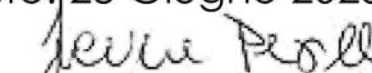

.....  
Responsabile Ufficio Tecnico.  
**Arch. Saveria Petillo**

**OGGETTO:**

**RILIEVO FOTOGRAFICO**



**PROGETTISTI INCARICATI:**

Tav:

**ril.03**

**Arch. Roberto Bassignani - (Capofila)**

**Prof. Arch. Francesco Murano**

Il tecnico  
numero professionale / progettista

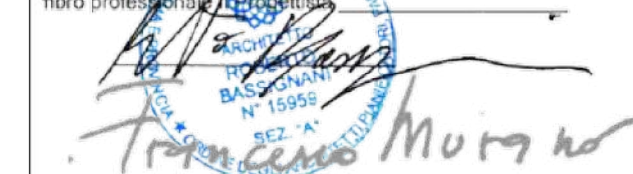

**R.U.P.:**

**Dott. Sara Colantonio**

Data:

Giugno 2023

Scala:

1:200



4.1



4.2

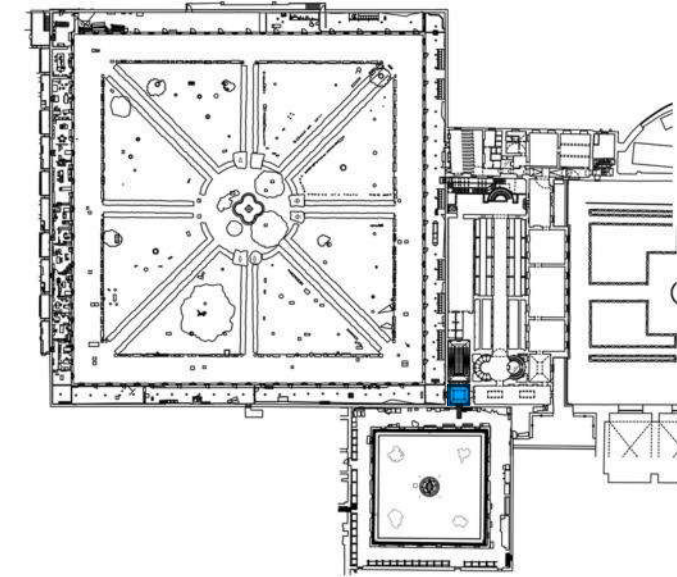

ROOM 4



4.3



4.4

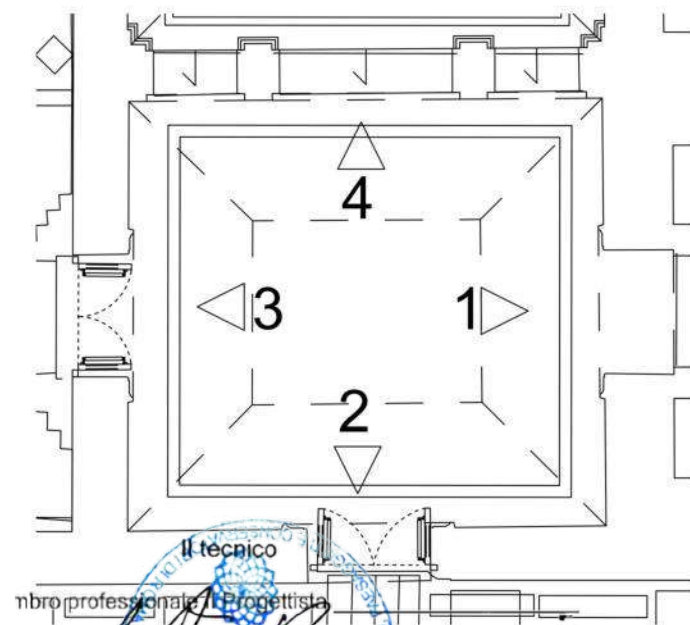

Il tecnico  
numero professionale / Progettista  
ARCHITETTO  
ROBERTO  
BASSIGNANI  
N° 15959  
ORDINE DEGLI ARCHITETTI DELLA PROV. DI PAVIA  
Murgia

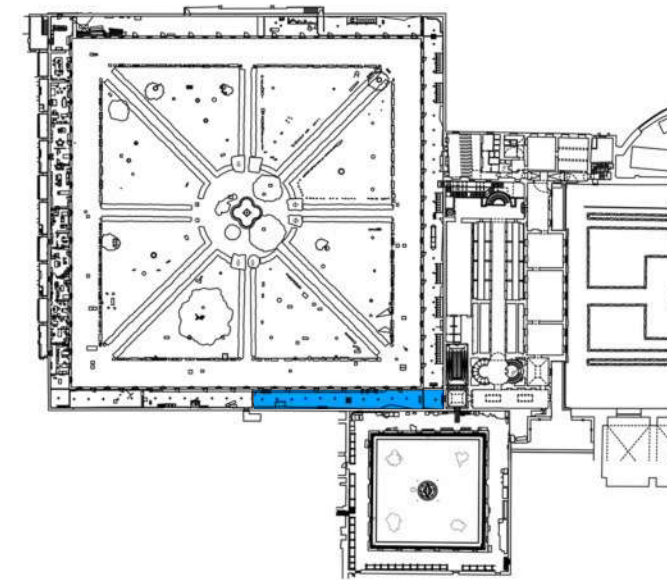

ROOM 6.1

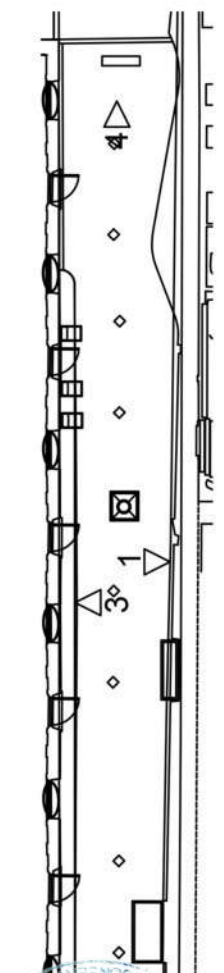

Il tecnico  
 numero professionale / ingegnere / architetto  
 FRANCESCO MORINO  
 BASIGNAN  
 N° 15959  
 ASSOCIAZIONE DEGLI ARCHITETTI ITALIANI



6.5



6.6

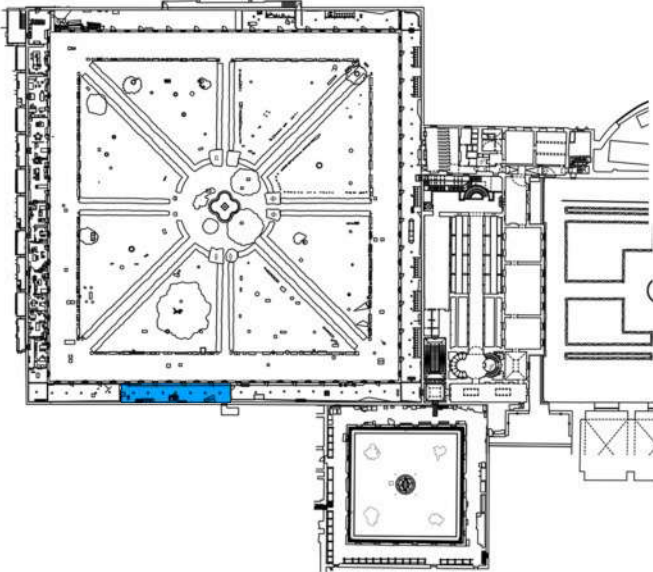

ROOM 6.2



6.7



6.8

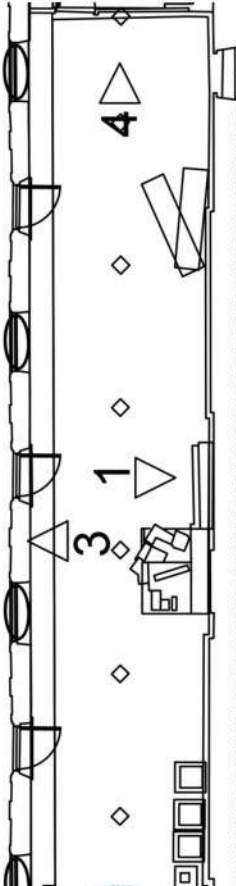

tecnico  
mbro professionale di progettista  
ARCHITETTO  
BASSIGNANI  
SEZ. 'A'

Francisco Murano



6A.1



6A.2

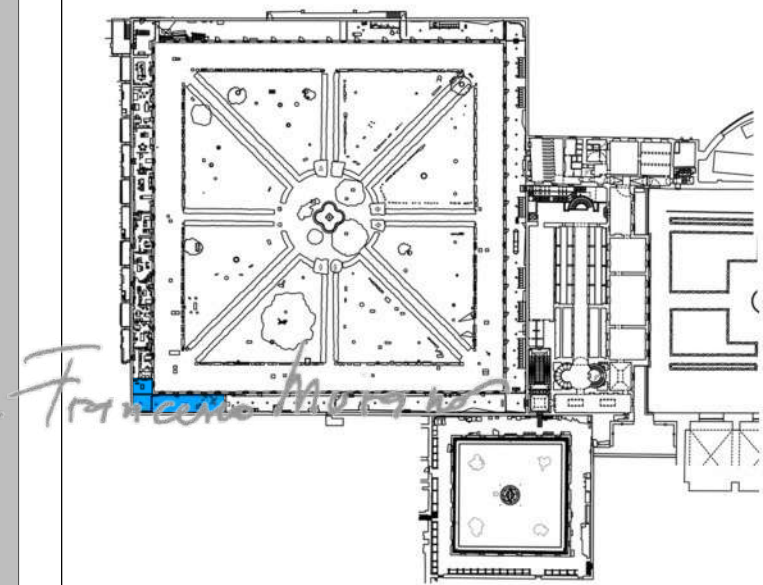

# ROOM 6A



6A.EXTRA

6A.3

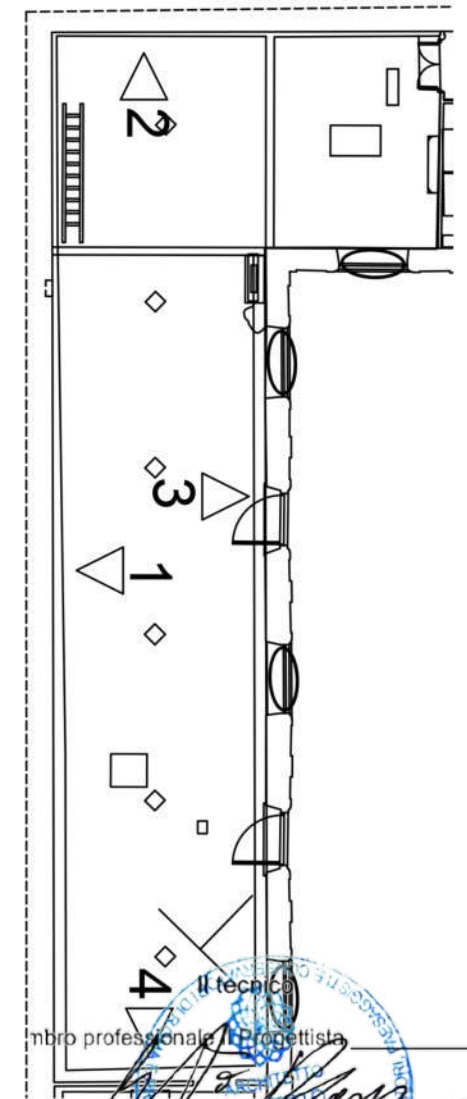

Il tecnico  
Ingegnere  
BASSIGNAN  
N° 15959  
Trincenzo Morano  
ORDINE DEGLI ARCHITETTI



6B.1

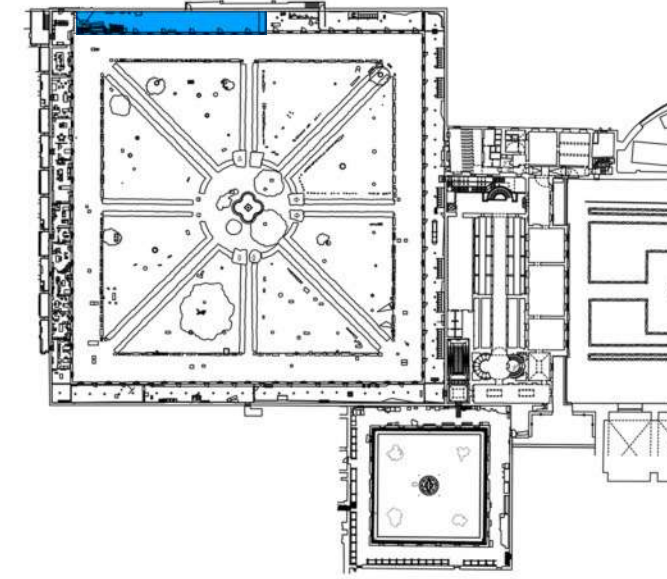

ROOM 6B



6B.3



6B.2



6B.4

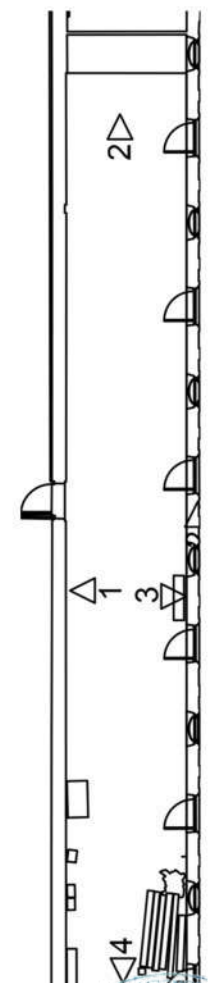

Il tecnico  
 nbro professionale / progettista  
 FRANCESCO MURANO



6C.1



6C.3



6C.2



6C.4

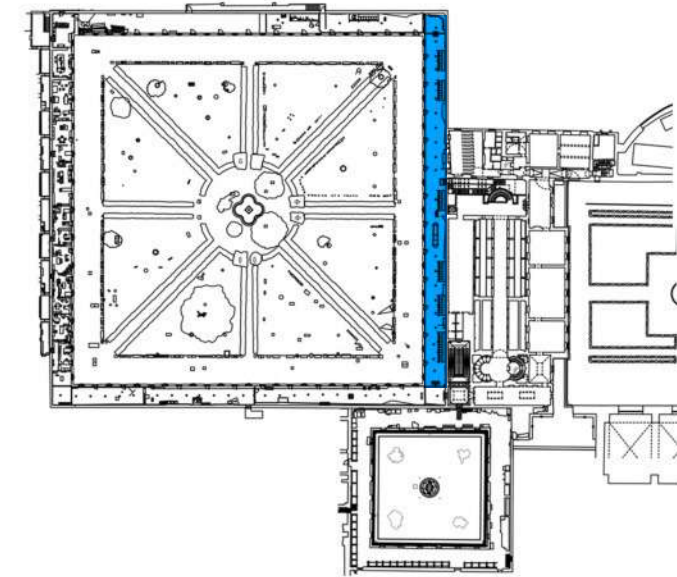

ROOM 6C

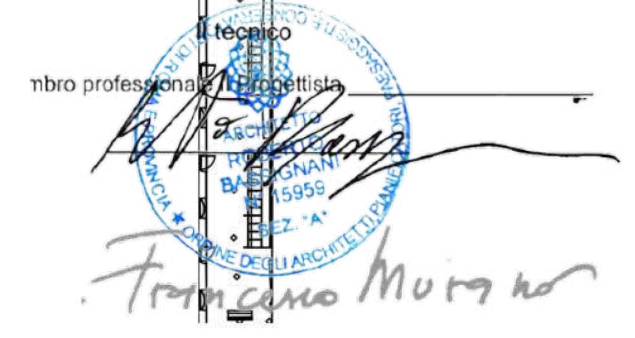
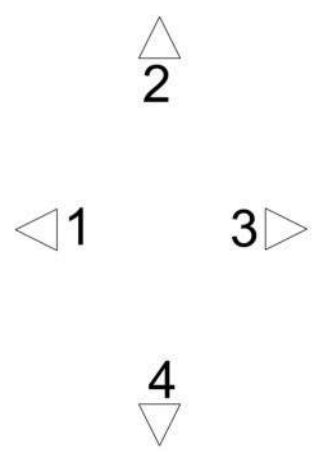
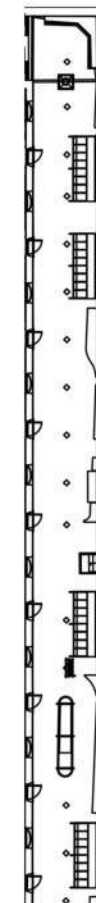



6D.1



6D.2



6D.3



6D.4

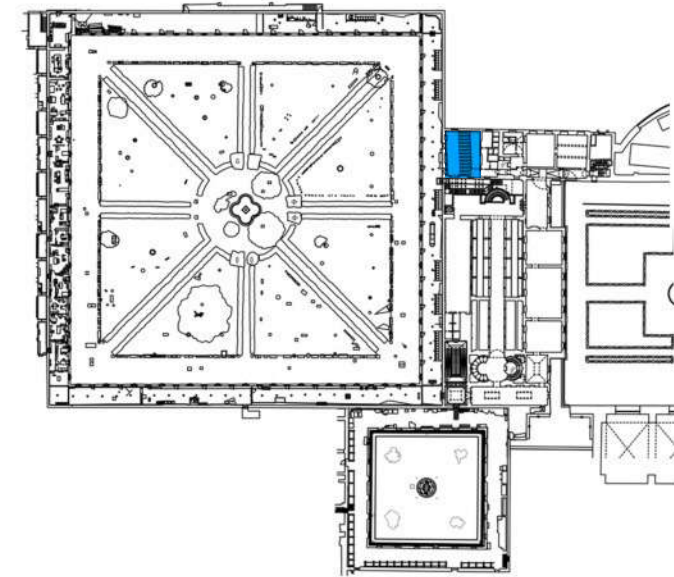

## ROOM 6D

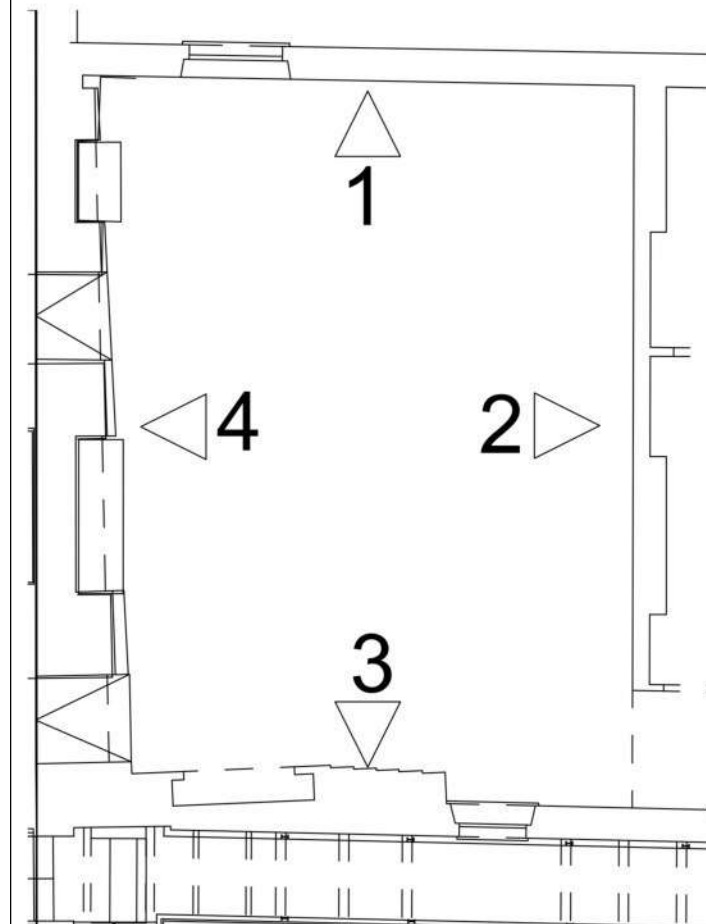



6E.1



6E.3

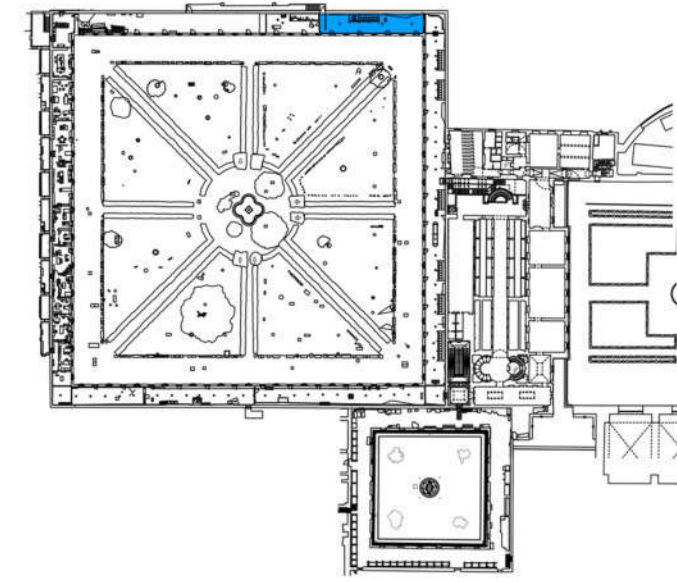

ROOM 6E



6E.2



6E.4

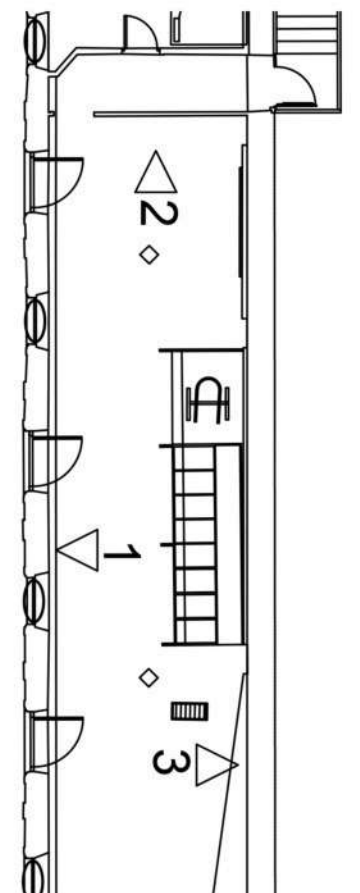

Il tecnico  
 nbro professionale / Progettista  
 FRANCESCO MURIGNO  
 ARCHITETTO  
 BASSONANO  
 N° 15968  
 SEZ. A  
 ORDINE DEGLI ARCHITETTI DELLA PROV. DI TORINO



7.1



7.2



7.3



7.4

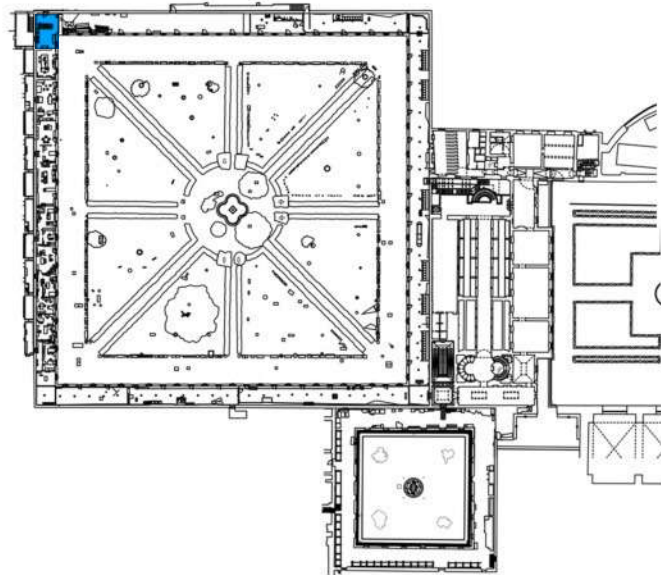

ROOM 7

il tecnico  
nbro professionale / Progettista

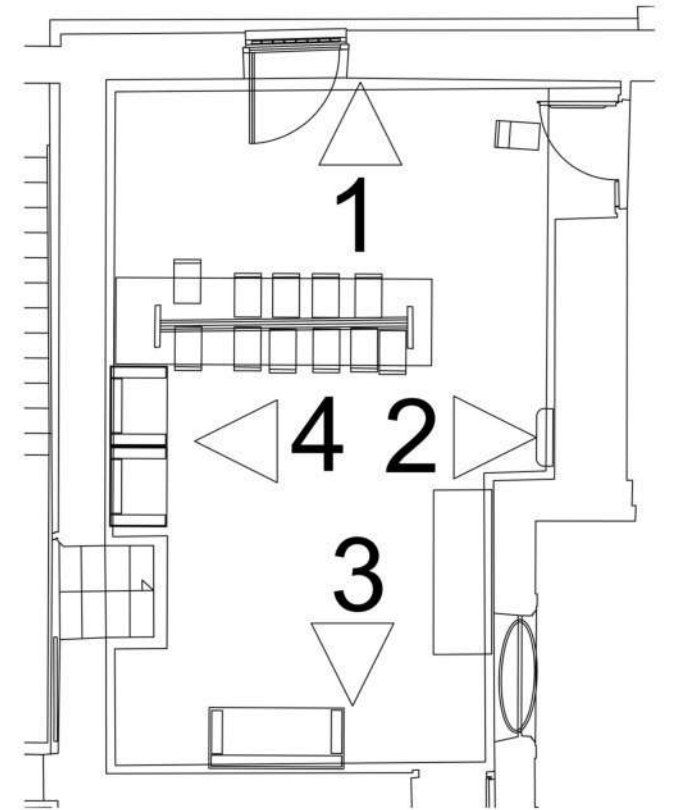



11.2



11.4

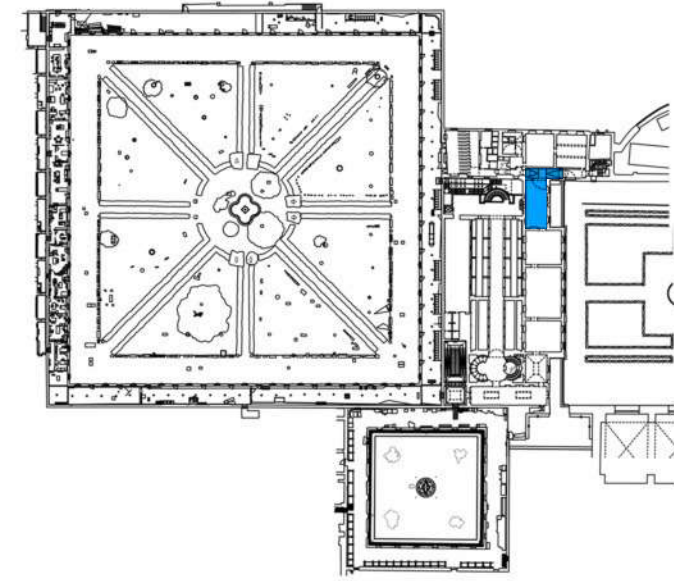

ROOM 11



11.1



11.3

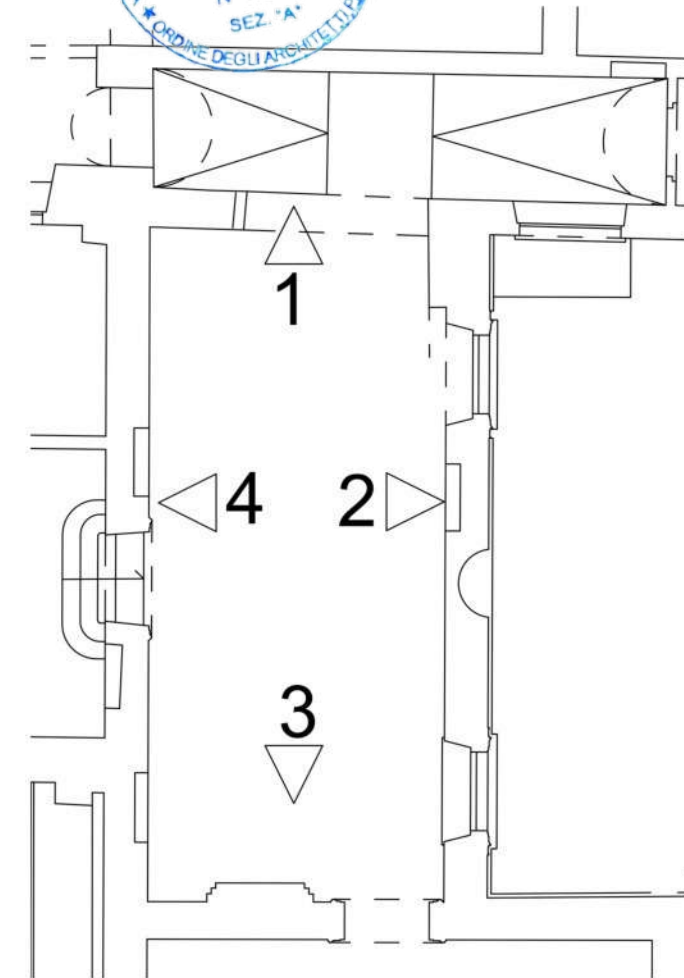



12.1



12.2



12.3



12.4

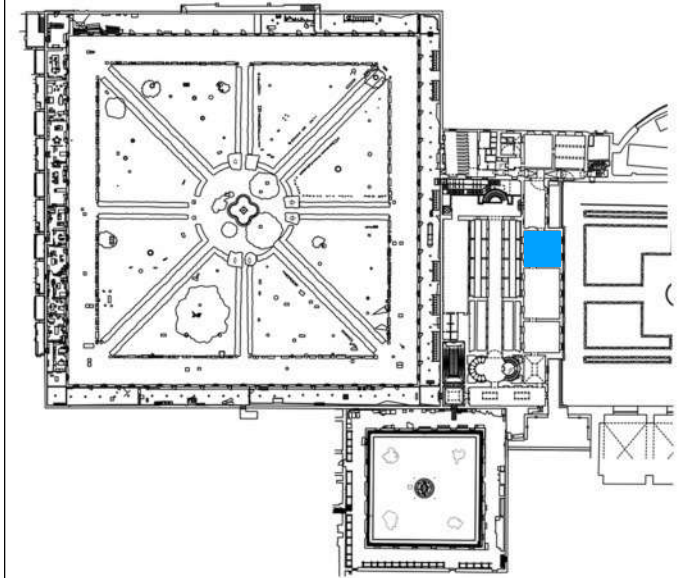

## ROOM 12

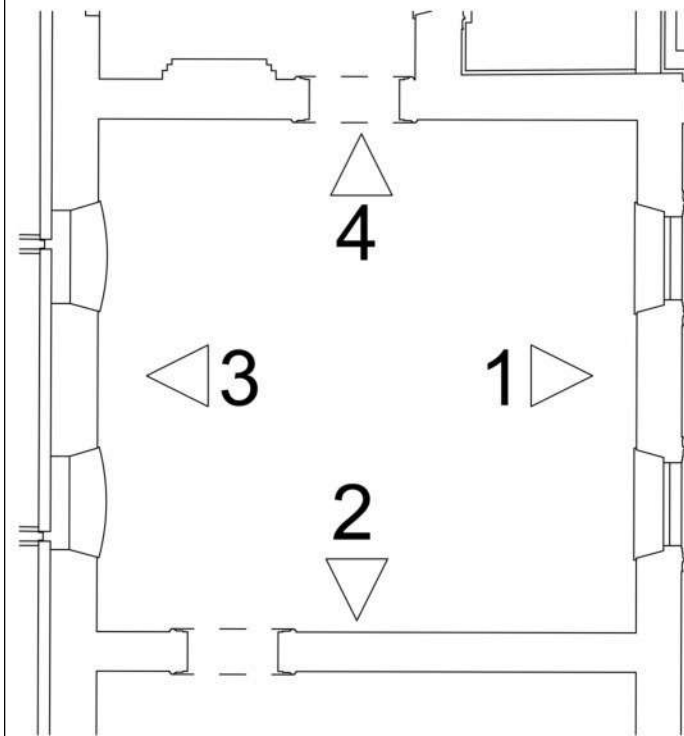



13.1



13.2



13.3



13.4

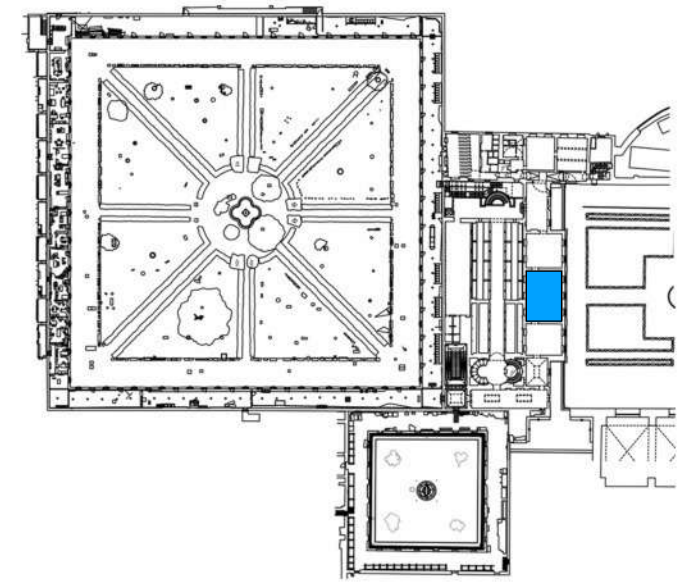

ROOM 13

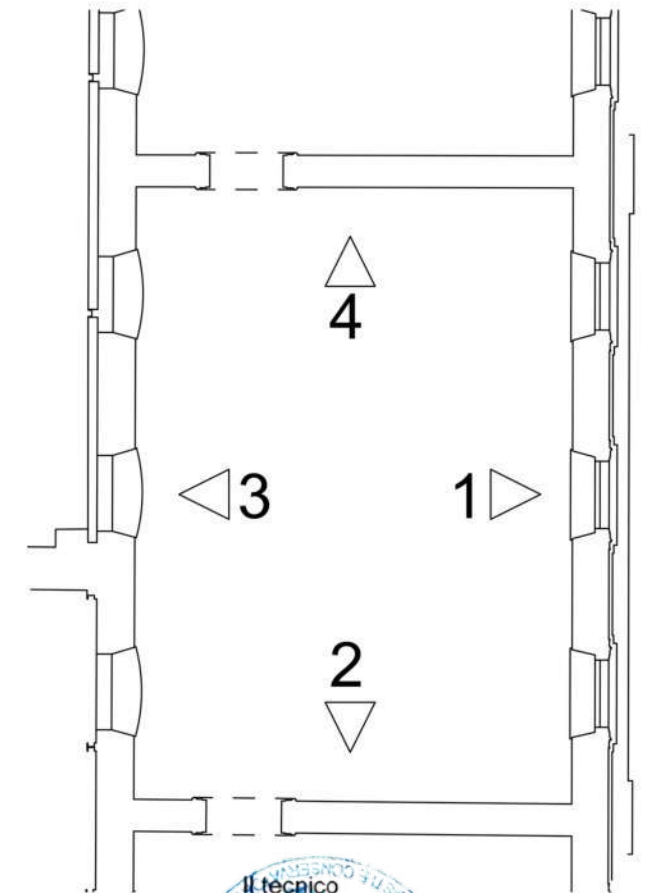



14.1



14.2



14.3



14.4

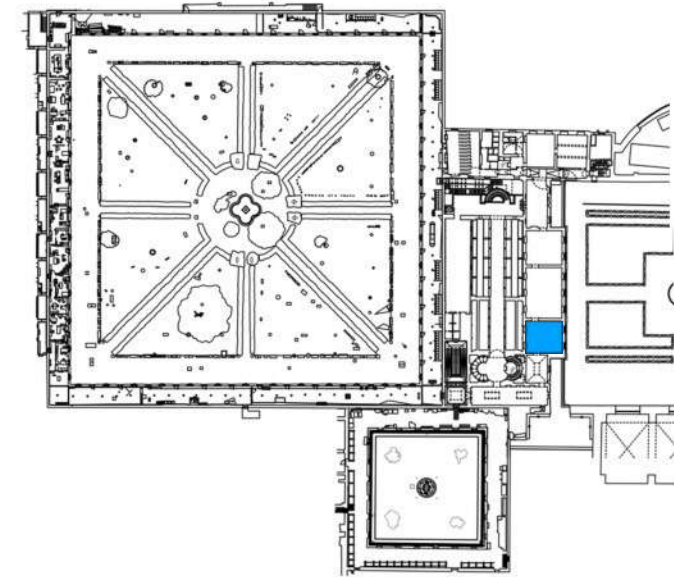

## ROOM 14

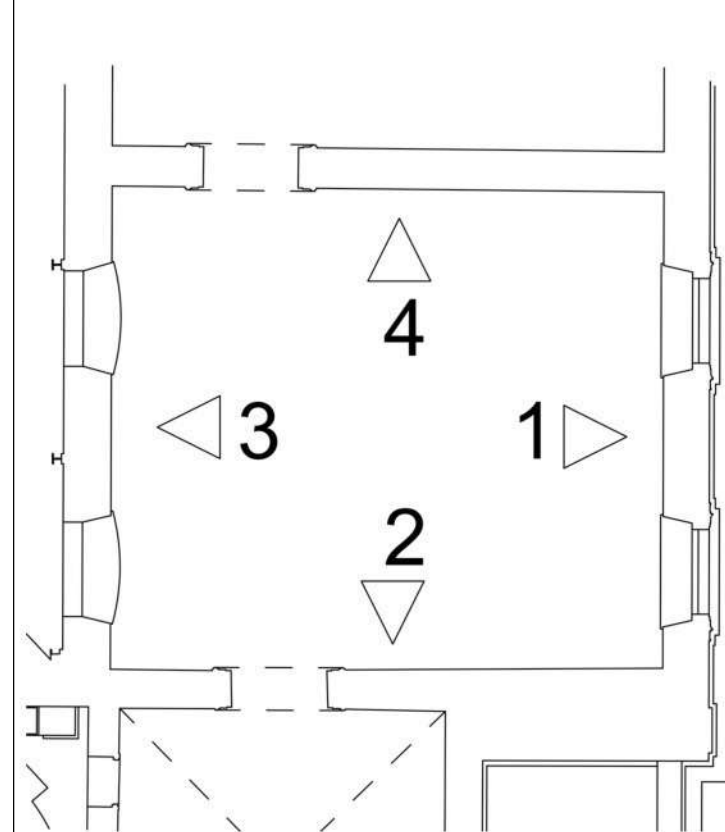



15.1



15.2



15.3



15.4

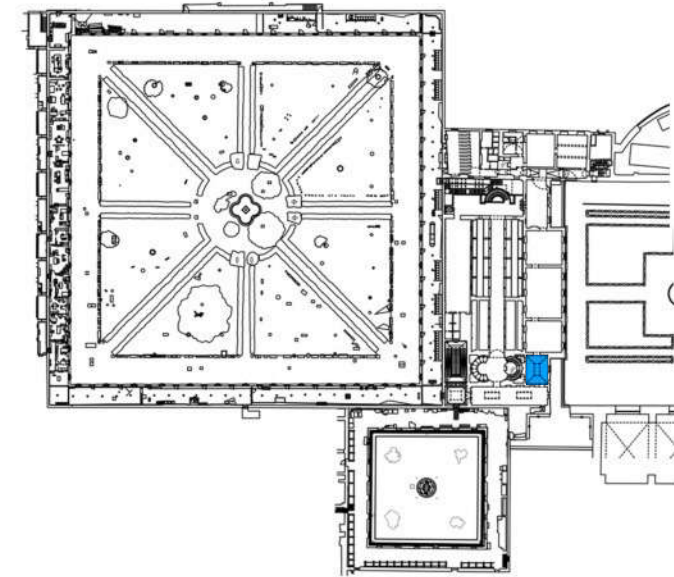

## ROOM 15

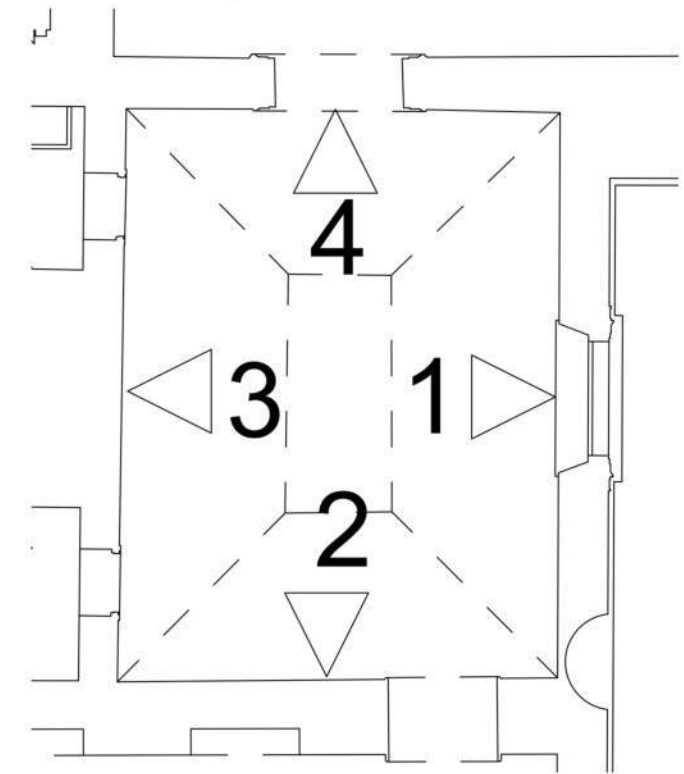



16.2



16.4

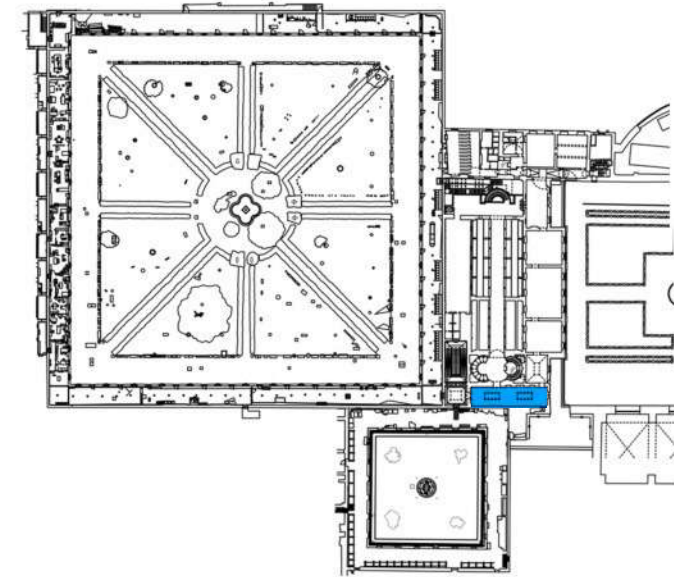

ROOM 16

Il tecnico  
 Architetto  
 Francesco Morghino  
 BASSIGNAN  
 N° 15959  
 Ordine degli Architetti

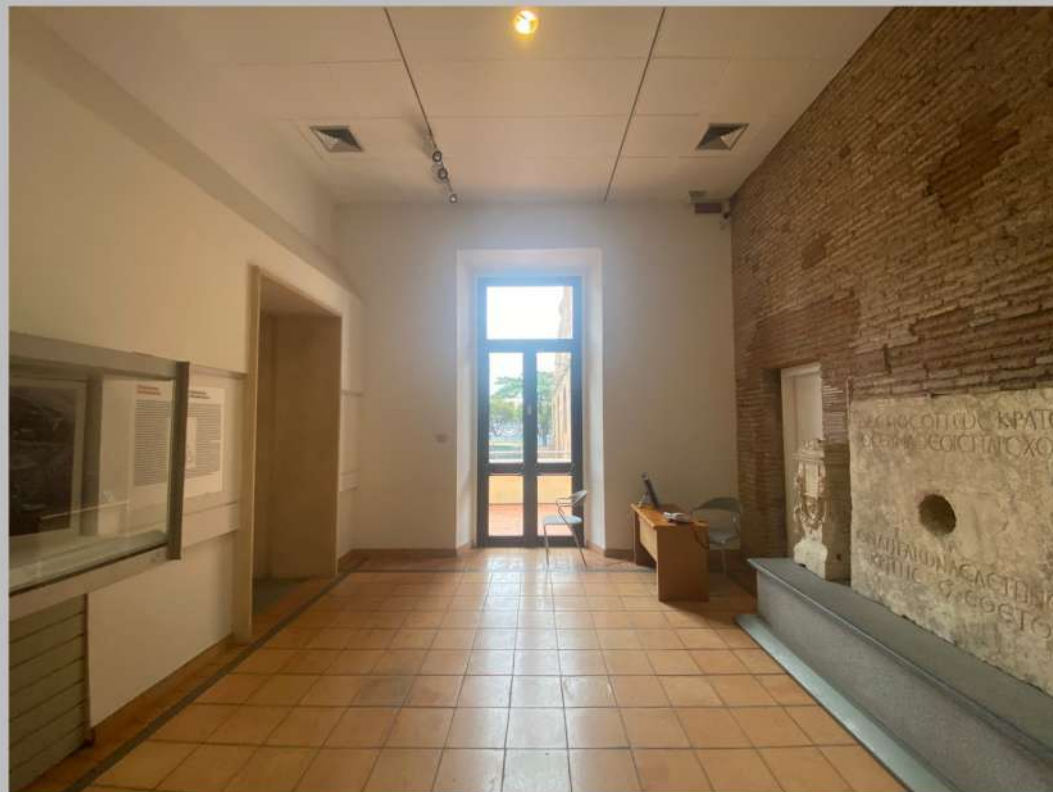

16.1



16.3

